

PLAN +225 (B.O.P.)
1:100

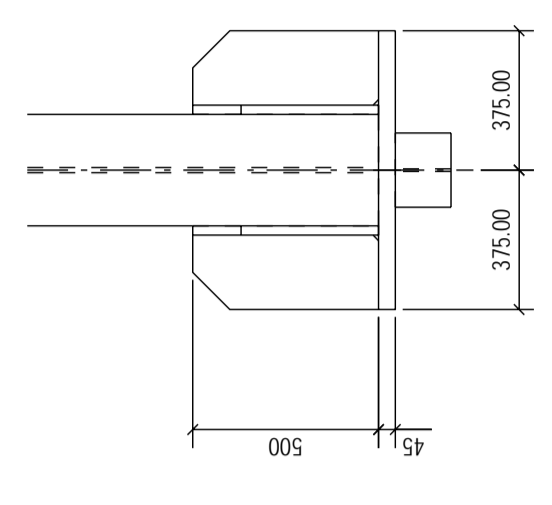
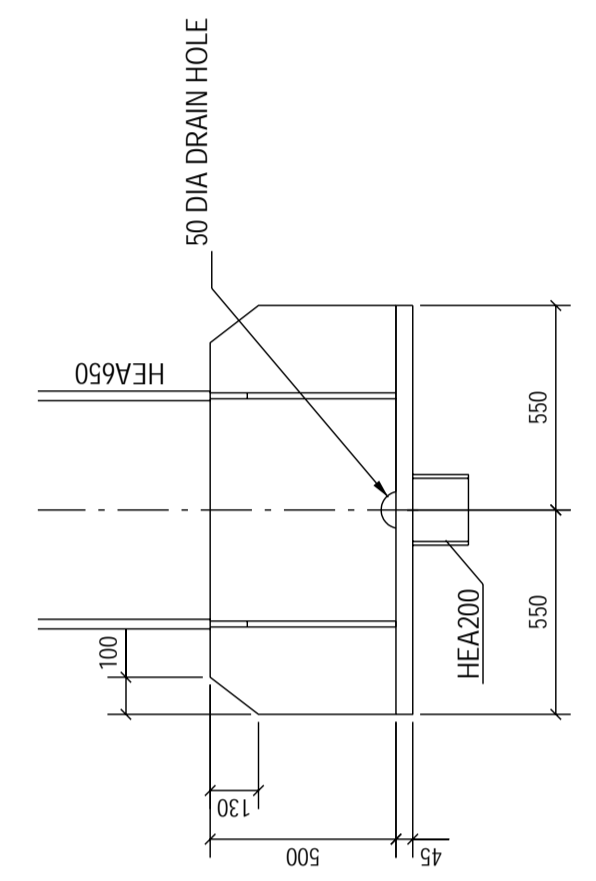
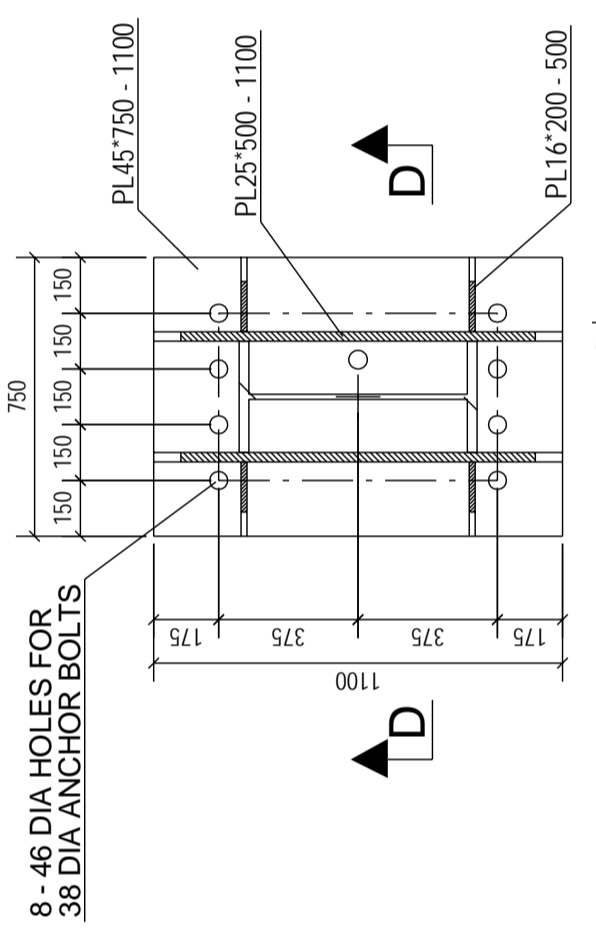
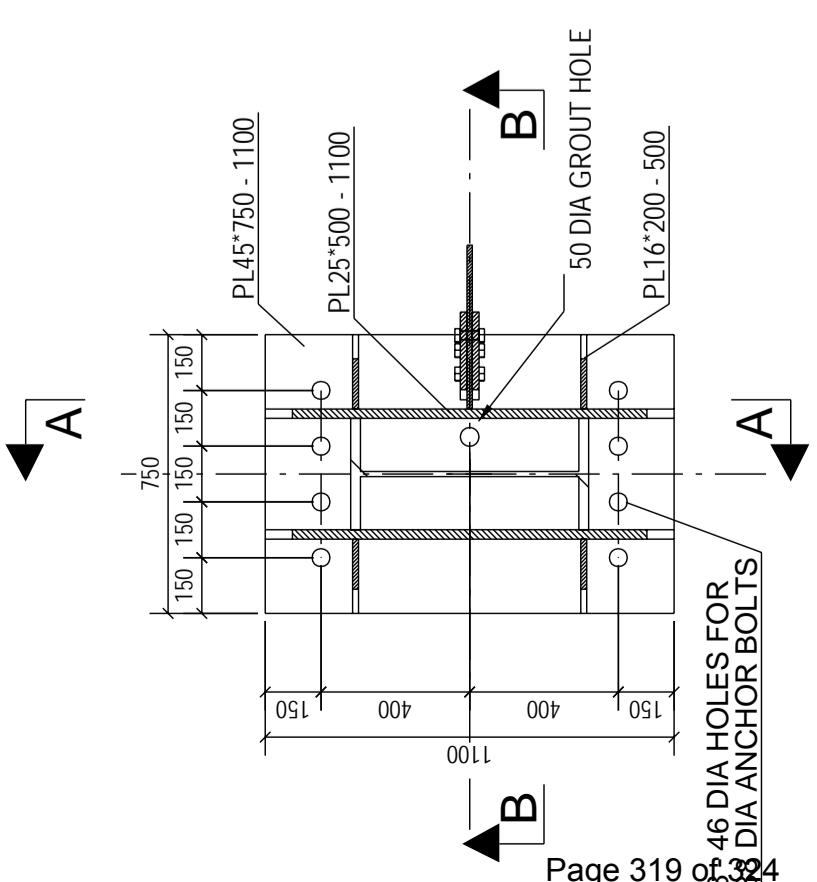

DETAIL A
1:20

SECTION A-A
1:20

SECTION B-B
1:20

DETAIL B
1:20

SECTION C-C
1:20

SECTION D-D
1:20

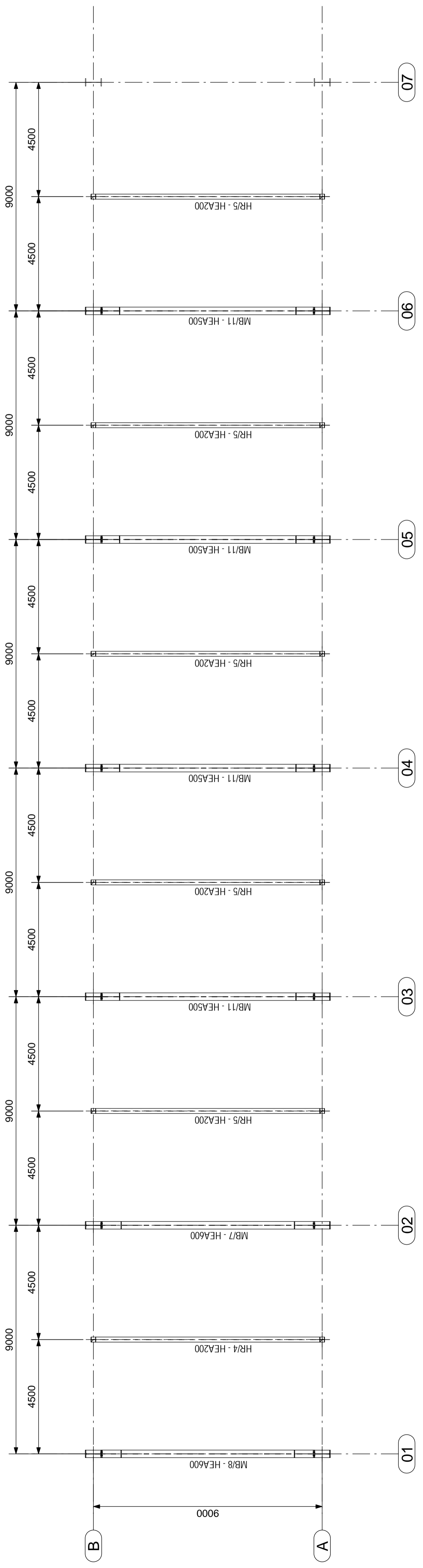

PLAN +5000.00
1:100

N°	MARCA REV.	DESCRIZIONE	REVISIONE	DATA	REV.
		PIAN BASEPLATE AND AT EL. -5000			
		CONTRATTO			
		MODELATO DA			
		CONTRATTO N°			
		PIPE RACK STD-9M			
		SCALE	1:20		1:100
		DESIGNO N°	G 121		
		REVISIONE N°			0

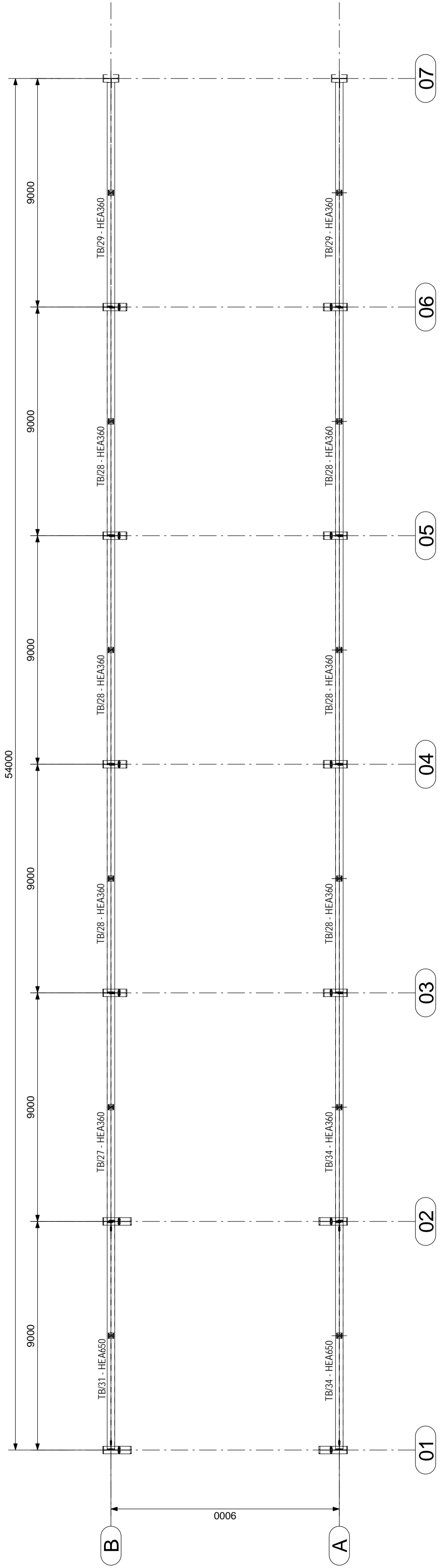

PLAN +6250.00
1:100

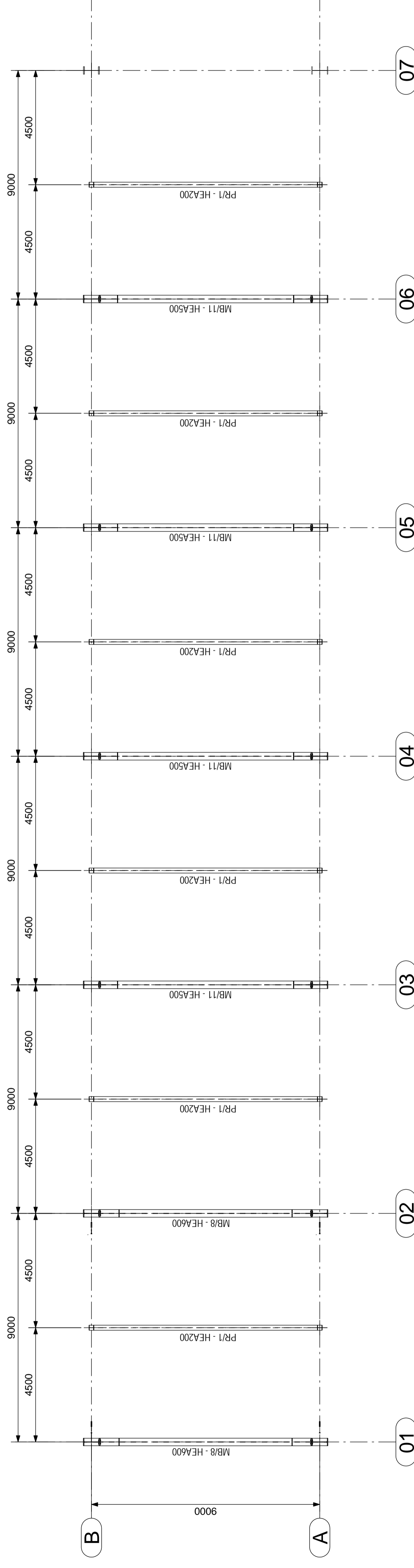

PLAN +7500.00
1:100

N°	MARCA REV.	DESCRIZIONE	REVISIONE	DATA REV.
		TITOLO DISEGNO	PLANS AT EL. +6250 AND +7500	
		CONTRATTO		
		MODELATO DA		PUBBLICATO IL
		CONTRATTO N°		SCALE 1:100
		DISEGNO N°	G B	REVISIONE N° 0

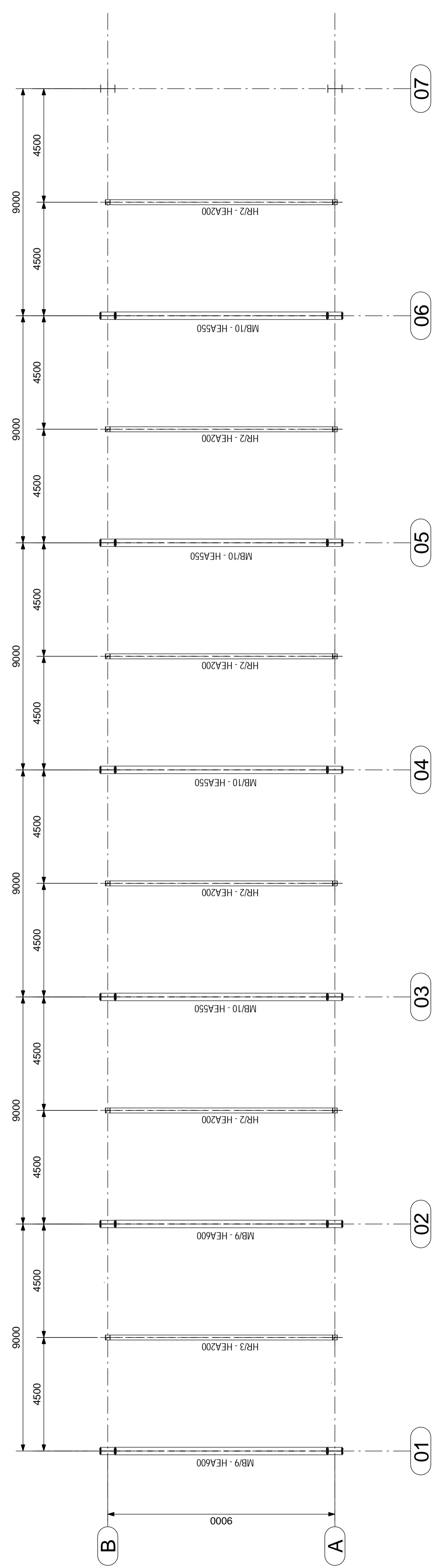

PLAN +10000.00
1:100

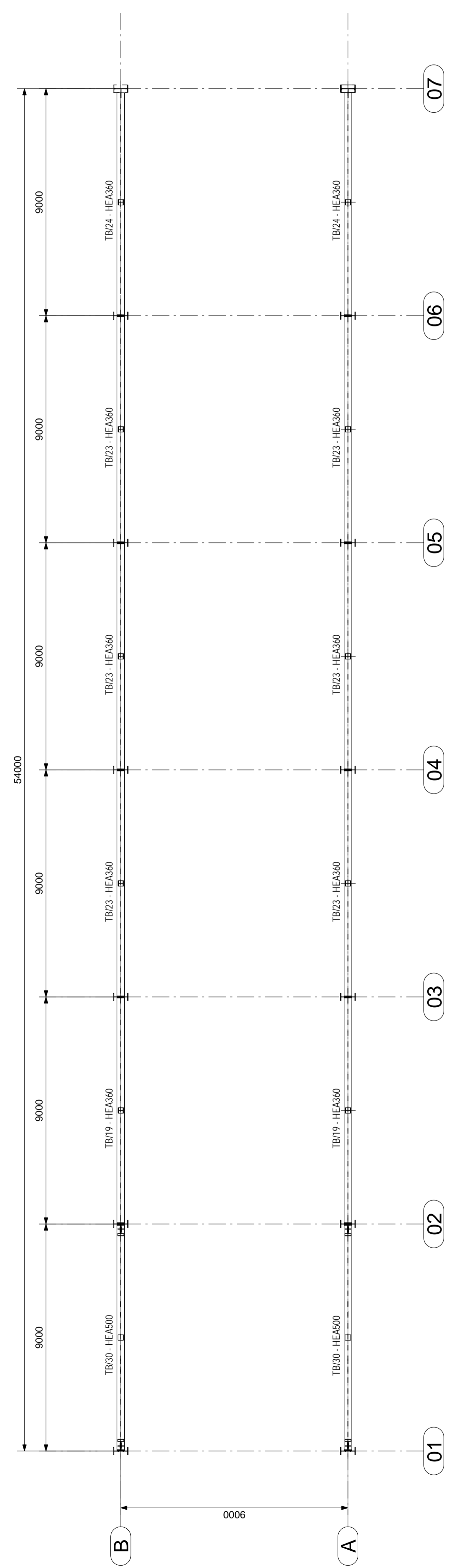

PLAN + 12675.00
1:100

N°	MARCA REV.	DESCRIZIONE	REVISIONE	DATA REV.
		TITOLO DISEGNO	PLANS AT EL. +10000 AND +12675	
		CONTRATTO		
		MODELATO DA		PUBBLICATO IL
		CONTRATTO N°	PIPE RACK STD-9M	SCALE 1:100
		DISEGNO N°	G H	REVISIONE N° 0

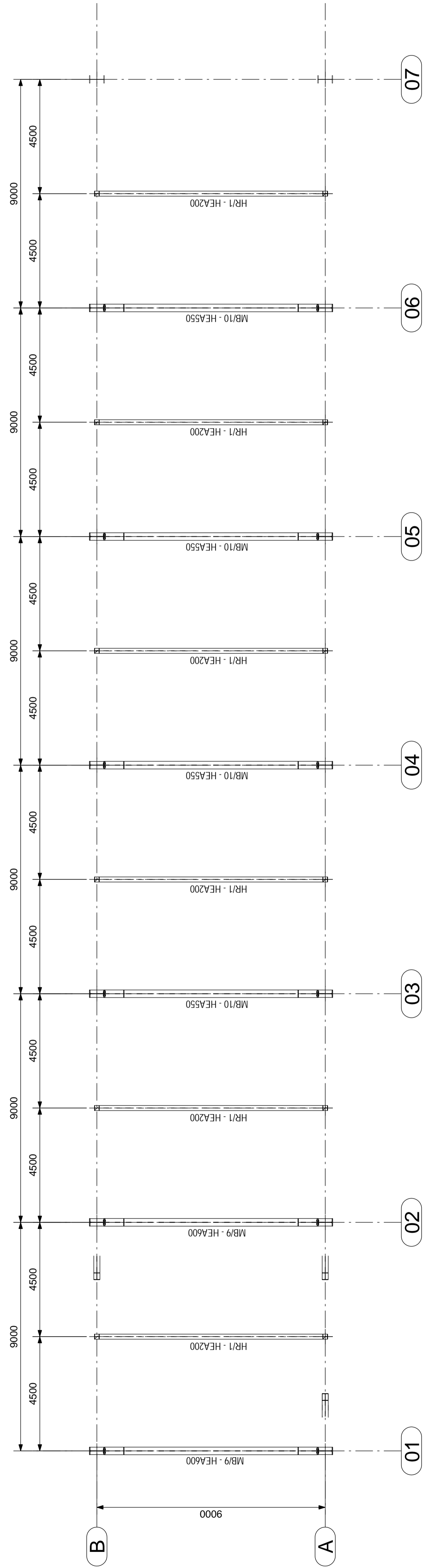

PLAN +15350.00
1:100

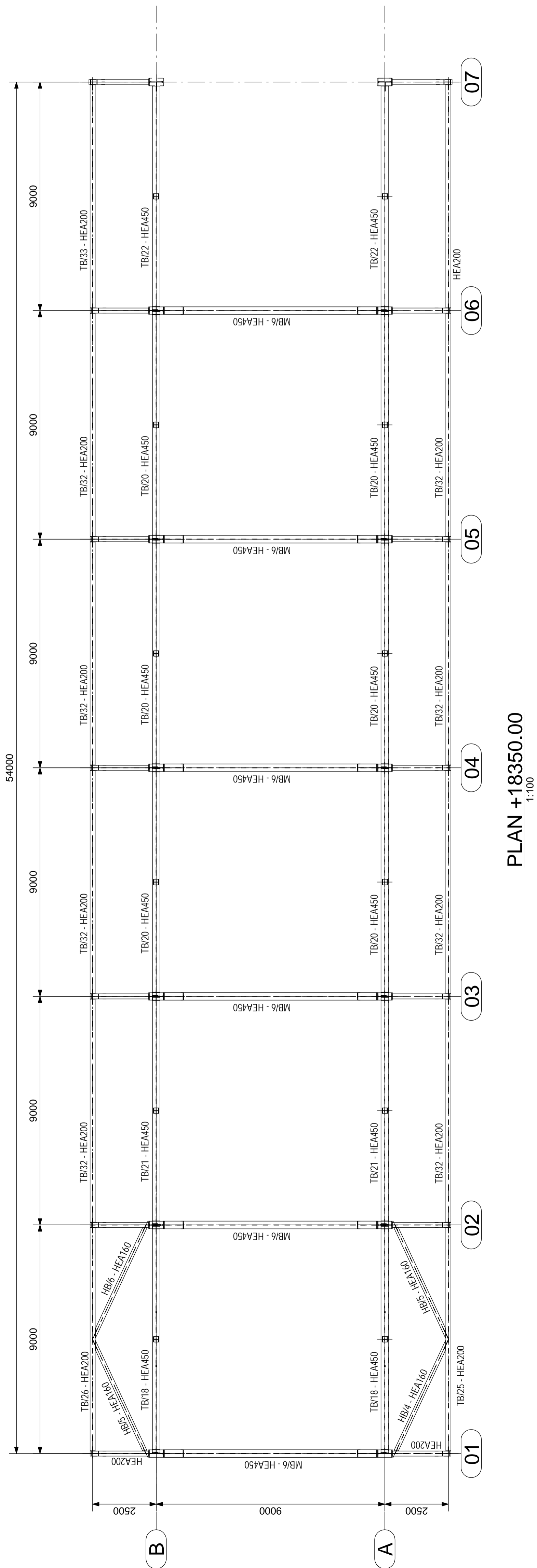

PLAN +18350.00
1:100

N°	MARCA REV.	DESCRIZIONE	REVISIONE	DATA	REV.
		TITOLO DISEGNO	PIANE AT EL. +15350 AND +18350		
		CONTRATTO	MODELATO DA		
		CONTRATTO N°	PIPE RACK STD 9M	SCALE	1:100
		DISEGNO N°	G [B]	REVISIONE N°	0

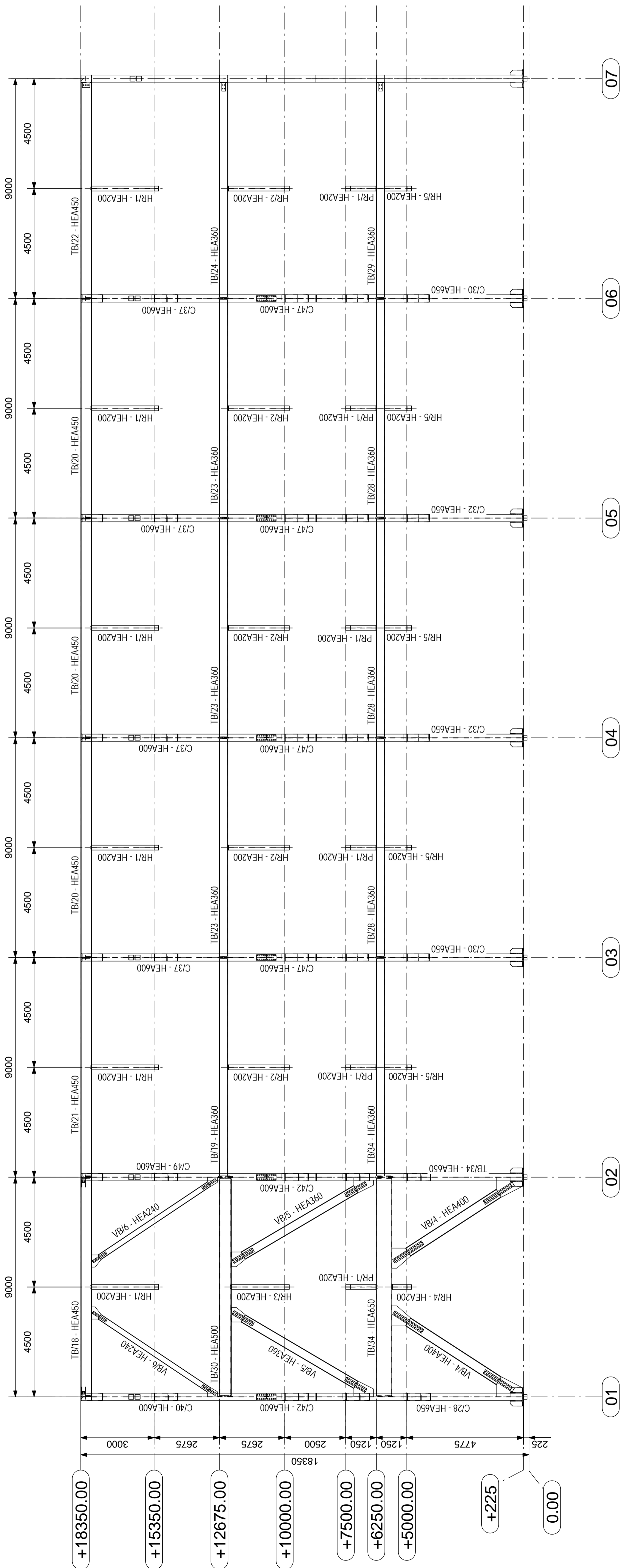

ALIGNMENT A
1:100

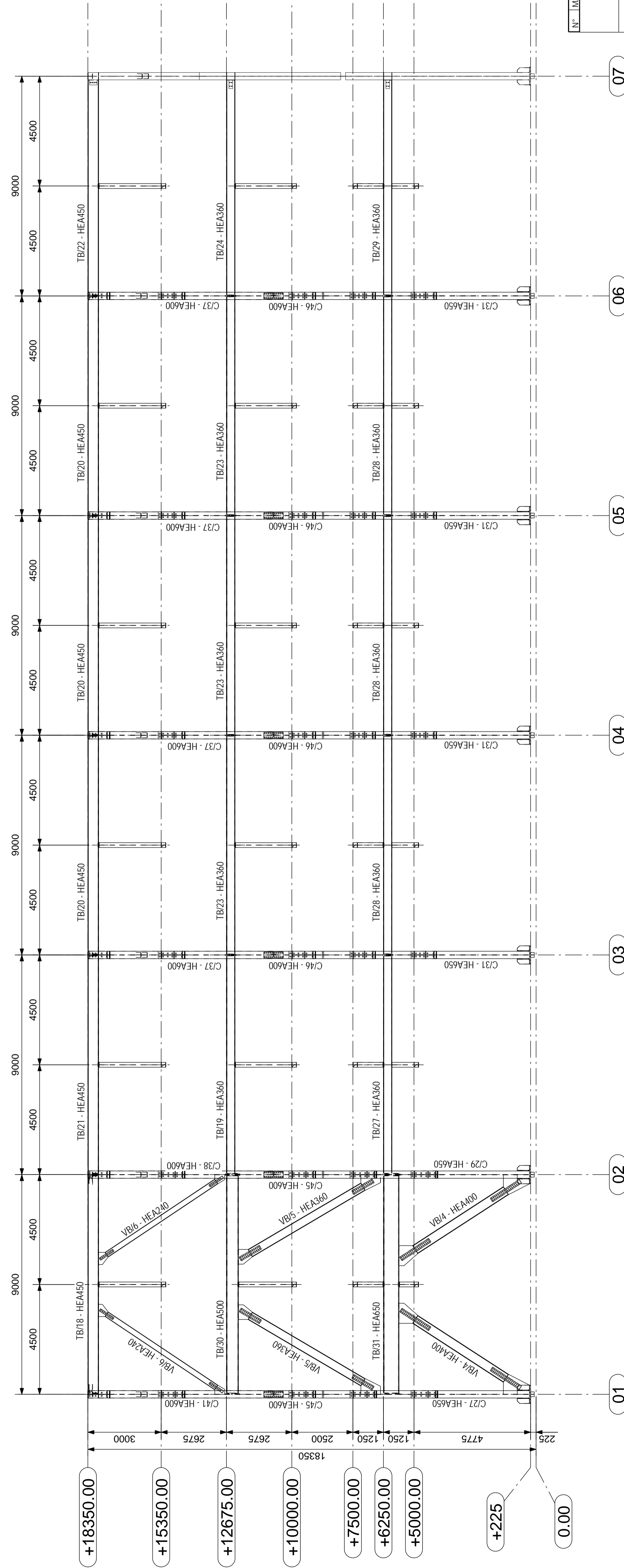

ALIGNMENT B
1:100

N°	MARCA REV.	DESCRIZIONE	REVISIONE	DATA	REV.
ELEVATION GRIDS A & B					
TITOLO DISEGNO					
CONTRATTO					
MODELLO DA					
CONTRATTO N°					
DISEGNO N°					
SCALE					
1:100					
PIPE RACK STD-9M					
G 6l					
REVISIONE N°					
0					

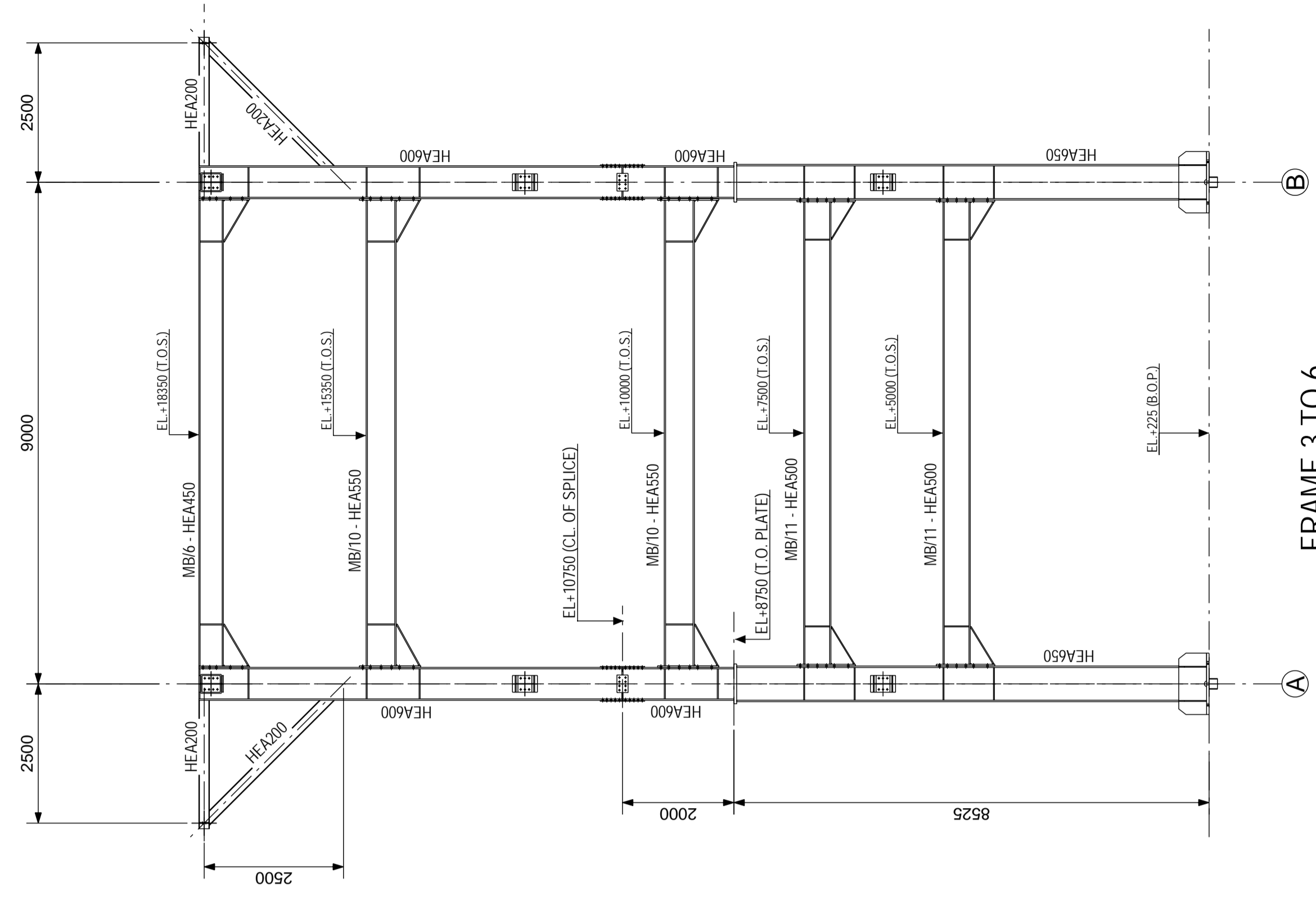

FRAME 3 TO 6
1:75

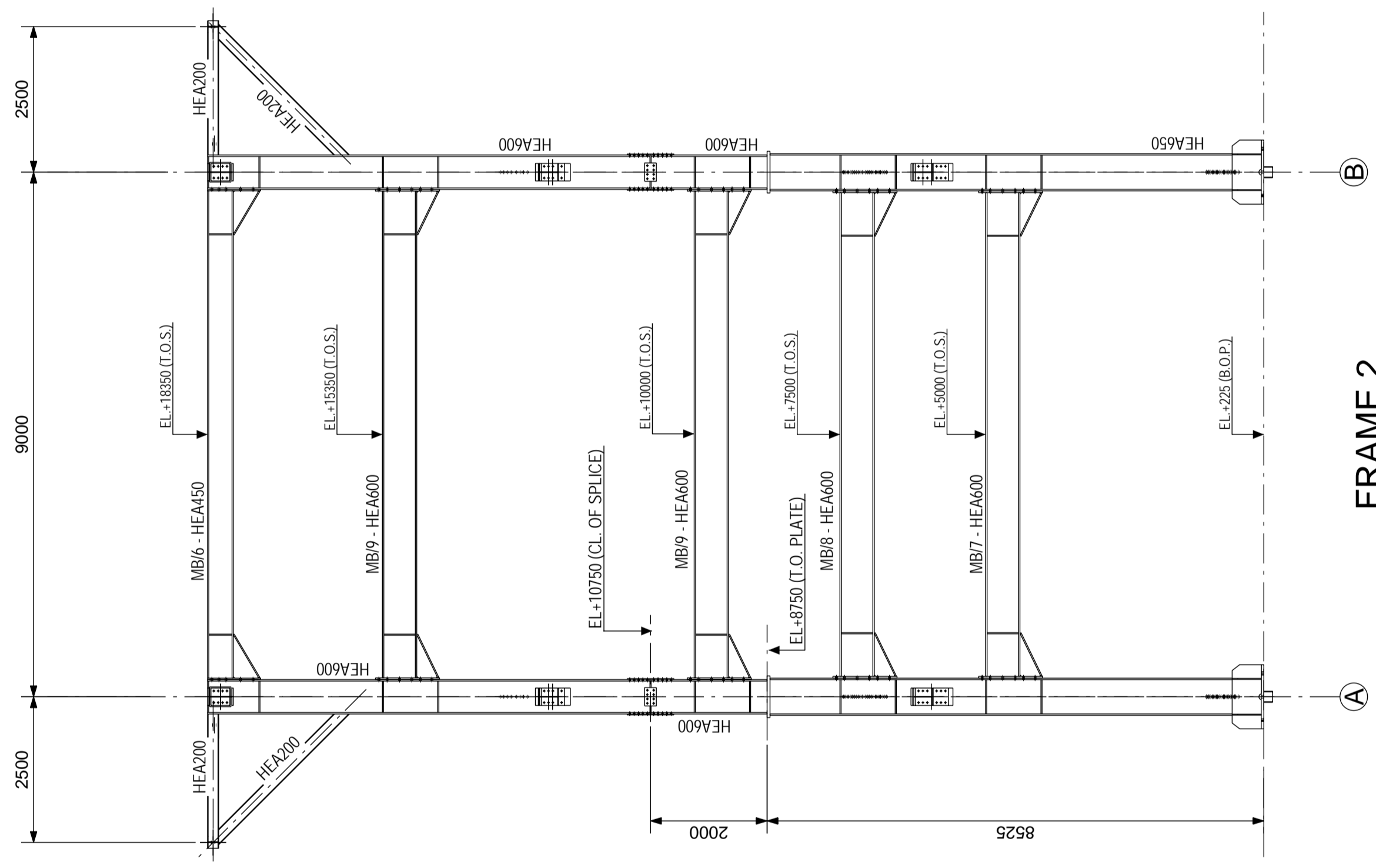

FRAME 2
1:75

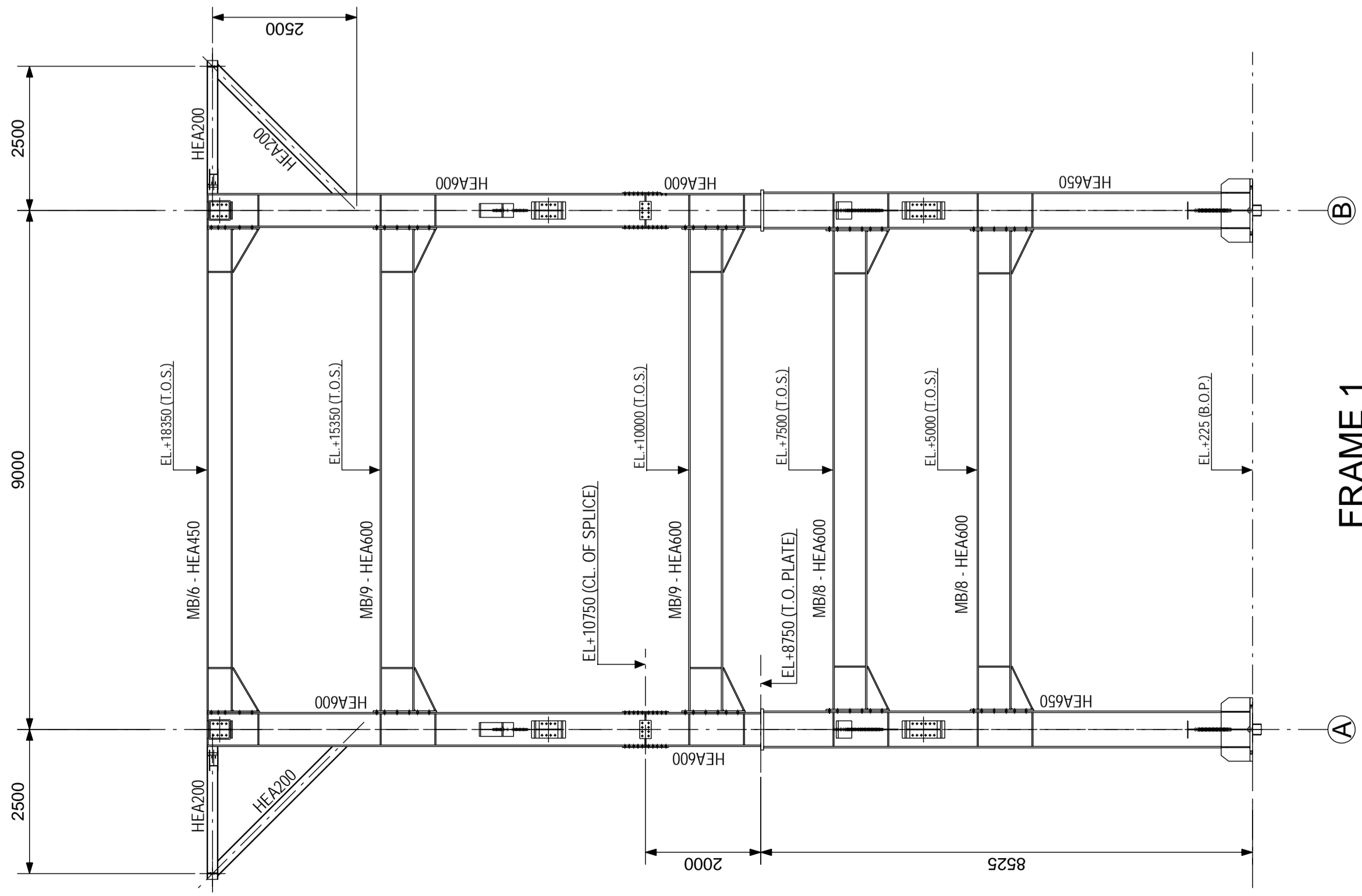

FRAME 1
1:75

N°	MARCA REV.	DESCRIZIONE	REVISIONE	DATA REV.
TITOLO DISEGNO				
FRAMES 1, 2 & 3 TO 6				
CONTRATTO				
MODELATO DA				
PUBBLICATO IL				
CONTRATTO N°				
PIPE RACK STD-9M				
SCALE				
1:75				
DISEGNO N°				
G BI				
REVISIONE N°				
0				